



Trialum

CATÁLOGO DE ACCESORIOS Y HERRAJES

 GRUPO
PLASTIGAS



RDO
Red de Distribuidores
Oficiales



ÍNDICE

Detalle	Referencia
MÓDENA	01
MÓDENA 2	09
A30	17
MÓDENA RPT	24
A40	31
A40 RPT	38
PIEL DE VIDRIO	45
A40 CRISTAL	48





Módena

ACCESORIOS

B-9



PERFIGOM 10505224 X100

Burlete Tope Mosquitero

B-29



PERFIGOM 10501316 X100

Burlete Cuña 2 mm

B-30



PERFIGOM 10501317 X100

Burlete Cuña 3 mm

B-31



PERFIGOM 10501318 X100

Burlete Cuña 4 mm

B-52



PERFIGOM 10501336 X100

Burlete Interior Doble Contacto

B-57



PERFIGOM 10501341 X100

Burlete Tapa Premarco

B-60



PERFIGOM 10501344 X100

Burlete U para vidrio

B-66



PERFIGOM 10501349 X100

Burlete Hermeticidad Junta Abierta

B-67



PERFIGOM 10501350 X100

Burlete Hermeticidad Doble Contacto



B-68



PERFIGOM 10501351 X100

Burlete Exterior para vidrio

B-69



PERFIGOM 10501352 X100

Burlete Marco-Premarco

B-70



PERFIGOM 10501306 X100

Burlete Cierre Mosquitero

C-14

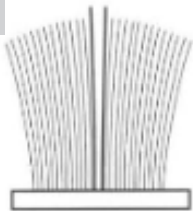

MONPAT 1074110201NE4 X300
AXAL 10721500007602 X300

Felpa 7 x 6 con Fin-Seal

E-62



AXAL 11100003062 X100

Escuadra de Alineamiento 4148

E-66



API 1058E66 X100
TANIT 10535008 X100

E-67



TANIT 10535014x40
AXAL 10300002067x1

Escuadra Suplementaria Hoja
Puerta de Rebatir

E-68 ALUMINIO



AXAL 1072300002068 X1

Escuadra de Armado Premarco

E-68 NYLON



API 1058E68 X100

Escuadra de Armado Premarco

E-69



MONTICELLI 1060E69 x1
COMUNELLO 19000002103x1
AXAL 10720800002069x1

Escuadra de Armado Marcos y Hojas

E-70



MONTICELLI 1060E70x1
COMUNELLO 19000002105x1
AXAL 1072800002070x1

Escuadra Hoja Puerta de Rebatir

E-71 TANIT



TANIT 10535021x20

Escuadra Travesaño Angosto Paño Fijo

E-71 MONTICELLI

MONTICELLI 1060E71Mx1

Escuadra Travesaño Angosto Paño Fijo

E-72

TANIT 10535022x20

Escuadra Travesaño Ancho Paño Fijo

E-73 ALUMINIO

TANIT 10535033x50

Escuadra de Armado Mosquitero

E-73 NYLON

TANIT 10535023x100

 Escuadra de Armado Mosquitero
Puerta Vaivén

E-76

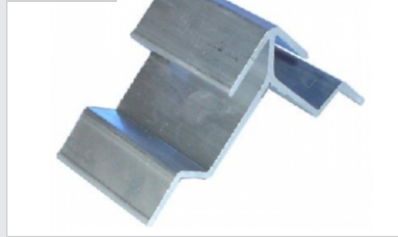
TANIT 10537505x100
E-77

TANIT 10535043x50

Escuadra de Armado Premarco

H-36 A

SECURISTYLE 1060STORM10 XPAR

Bisagra a Fricción 250

H-36 B

**SECURISTYLE 1060STORM16 XPAR
MONPAT 1074070130AI4 XPAR**

Bisagra a Fricción 450

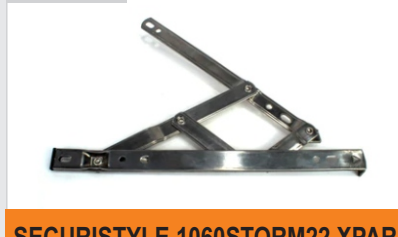
H-36 C

**SECURISTYLE 1060STORM22 XPAR
MONPAT 1074070131AI4 XPAR**

Bisagra a Fricción 550

H-36 D

**SECURISTYLE 1060STORM26 XPAR
MONPAT 1074070135AI4 XPAR**

Bisagra a Fricción 650

H-36 E

MONPAT 1074070132AI4 XPAR

 Limitador de Apertura para
Ventana Desplazable.

H-42

AXAL 10202153000 XPAR

Pasador para Ventana de Rebatir



H-42



GIESSE 102111010N X1

Pasador para Ventana de Rebatir

H-43



TANIT 10534033 X1

Traba Varillas

H-45

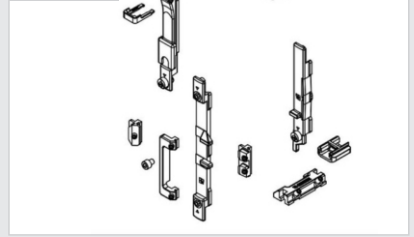

GIESSE 104704000x1

Mecanismo Básico Oscilo-Batiente

H-45

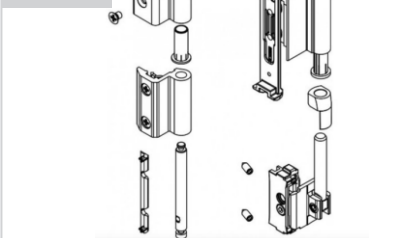

GIESSE 105711500/410x1

Bisagra No Coplanar Oscilo-Batiente

H-45



GIESSE 101039500/410x1

Falleba Prima Oscilo-Batiente

H-45

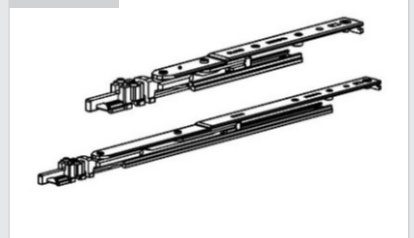

GIESSE 104284000x1

Compas T1 Corto Oscilo-Batiente

H-45

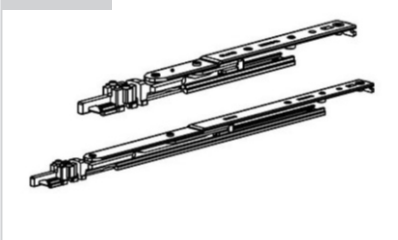

GIESSE 104285000x1

Compas T2 Largo Oscilo-Batiente

H-45

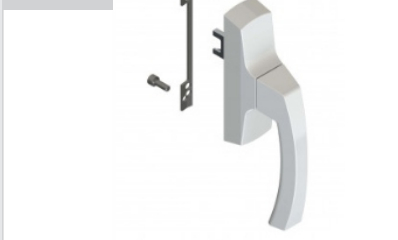

GIESSE 101084500/410x1

Falleba Asia Oscilo-Batiente

H-47



GIESSE 101076500/410x1

Falleba para ventana de abrir

H-47



GIESSE 101024500/410x1

Falleba para ventana de abrir

H-49



AXAL 10102111010x1

Pasador para ventana de abrir

H-50



GIESSE 102414500/410x1

Manija Doble Balancín



MONPAT 1074040302BL4x1

Manija Doble Balancín



GIESSE 102422500/410x1

Manija Doble Balancín



MONPAT 1074040302BL4x1

Manija Doble Balancín



GIESSE 102792500/410x1

Manija Doble Balancín



KALLAY 10902006802X1
MONPAT 1074160220NA4 X1
MONPAT 107410112NE4 X1
MONPAT 1074160312NA4 X1

Cerradura cilindro para puerta de rebatir



GIESSE 101704500/410x1

Cierre banderola



GIESSE 102040000KxPAR

Brazo sostén banderola 250mm



GIESSE 102041000KxPAR

Brazo sostén banderola 150mm



GIESSE 1029925000x1

Cierre lateral para corredizas beta



AXAL 10720300002612x1

Bisagra de 2 piezas flash



GIESSE 100120500x1

Bisagra de 2 piezas flash



AXAL 10720300002622x1

Bisagra de 3 piezas bridge

H-62



GIESSE 100600500Nx1

Bisagra de 3 piezas bridge

H-63



MONPAT 1074070317NE4x1

Brazo de empuje para ventiluz

H-63



GIESSE 100890500Nx1

Brazo de empuje para ventiluz

H-81



AXAL 10720300002812x1

Bisagra de 2 piezas para tercer hoja

H-81



GIESSE 100890500Nx1

Bisagra de 2 piezas para tercer hoja

H-82



GIESSE 100601500x1

Bisagra de 3 piezas para tercer hoja

H-89



GIESSE 103043500x1

Tirador para hojas ventana corrediza

H-91



GIESSE 101642500Nx1

Aldaba para ventana desplazable

H-91 MONACO



TANIT 1053506x1

Aldaba para ventana desplazable

H-92 ATENNAS



TANIT 1053520x1

Aldaba para ventana desplazable

R-40



MONPAT 1075013410NA1x1

Rueda regulable simple con rulemán

R-40



GIESSE 100806000x4

Rueda regulable simple con rulemán

R-42

MONPAT 1075013411NA1x1

Rueda regulable doble con rulemán

R-42

GIESSE 100801000x4

Rueda regulable doble con rulemán

R-43

**TANIT 10535069 INFERIOR X100
TANIT 10535060 SUPERIOR X100**

Patín Mosquitero

S-09

AXAL 10300002009x100

Grampa de Amure

T-69

TANIT 10534066x100

Tapa desagüe con válvula

T-87

**API 1058T87x100
TANIT 10535000x100**

Clip tapa premarco

T-88 NYLON

API 1058T88x100

Taco regulador marco-premarco

T-88 ZAMAC

TANIT 10535059x100

Taco regulador marco-premarco

T-89

**TANIT 10535002x100
API 1058T89x100**

Tope guía parante lateral

T-90

**TANIT 10535003x100
API 1058T90x100**

Tope guía parante central

T-91

**TANIT 10535004x100
API 1058T91x50**

Tapón lateral guía de condensación

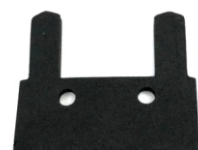
T-92

TANIT 10535028x100

Junta de estanqueidad marco



T-93



TANIT 10535038x20

Tapón central cruce de hojas

T-95



TANIT 10535013x200
API 1058T95x100

Tapa tornillo

T-96



API 1058T96x100

Clip contravidrios redondeados

T-97

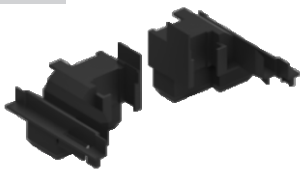

TANIT 10535063x25

Tapón encuentro de 2 hojas ventana de abrir con cámara compensadora

T-98

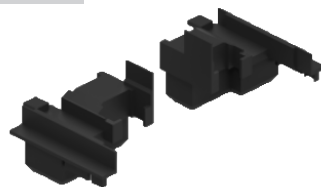

TANIT 10535064x25

Tapón encuentro de 2 hojas ventana de abrir DC y puerta de rebatir

T-99



TANIT 10535077x100

Porta felpa puerta de rebatir

T-100



TANIT 10535056x50

Tapa tornillo puerta de rebatir para T20

T-101



TANIT 10534193x100

Junta de estanqueidad marco de 3 guías

T-130



TANIT 10535097 X100

Boca desagüe caja de agua

T-131



TANIT 10535098 X100
API 1058T131 X100

Tapa desagote frontal caja de agua

PLETINA



GIESSE 103524590N X6MTS

Pletina de accionamiento

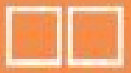

Módena2

ACCESORIOS

B-9



PERFIGOM 10505224 X100

Burlete Tope Mosquitero

B-29



PERFIGOM 10501316x100

Burlete Cuña 2 mm

B-30



PERFIGOM 10501317x100

Burlete Cuña 3 mm

B-31



PERFIGOM 10501318x100

Burlete Cuña 4 mm

B-57



PERFIGOM 10501341x100

Burlete Tapa Premarco

B-60



PERFIGOM 10501344x100

Burlete U para vidrio

B-67



PERFIGOM 10501350x100

Burlete exterior doble contacto

B-68



PERFIGOM 10501351x100

Burlete exterior para vidrio
ventanas batientes

B-69



PERFIGOM 10501352x100

Burlete hermeticidad marco-premarco



B-70



PERFIGOM 10501306x100

Burlete cierre mosquitero

B-79



PERFIGOM 10501359 X100

Burlete interior doble contacto

C-14

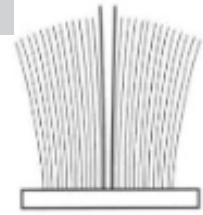

MONPAT 1074110201NE4 X300
AXAL 10721500007602 X300

Felpa 7 x 6 con Fin-Seal

E-62



AXAL 11100003062 X100

Escuadra de Alineamiento Tapa
Premarco 7732

E-66



API 1058E66 X100

Escuadra de Alineamiento Tapa
Premarco 7711

E-69



MONTICELLI 1060E69 X1
COMUNELLO 19000002103 X1
AXAL 10720800002069 X1

Escuadra de armado marcos y
hojas batientes

E-70



MONTICELLI 1060E70 X1
COMUNELLO 19000002105 X1
AXAL 1072800002070 X1

Escuadra de armado hoja puerta de
rebatir y hoja desplazable

E-71 MONTICELLI



MONTICELLI 1060371M X1

Escuadra travesaño paño fijo 6221

E-71



TANIT 10535021 X20

Escuadra travesaño paño fijo 6221

E-72



TANIT 10535022 X20

Escuadra travesaño paño fijo 6222

E-73 NYLON



TANIT 10535023 X100

Escuadra de armado mosquitero

E-73 ALUMINIO



TANIT 10535033 X50

Escuadra de armado mosquitero



E-77

TANIT 10535043 X50

Escuadra de armado premarco guillotina y 3 guías



E-83

**MONTICELLI 1060E83 X1
COMUNELLO 19000002110 X1
AXAL 10720800003083 X1**

Escuadra de armado marco corrediza 45°



E-97

**MONTICELLI 1060E97 X1
COMUNELLO 19000002107 X1
AXAL 10800002097 X1**

Escuadra de armado hojas corrediza 45°



E-98

TANIT 1053141 X100

Escuadra plástica para alineamiento hojas corrediza 45°



H-36 A

SECURISTYLE 1060STORM10 X PAR

Bisagra a Fricción 250

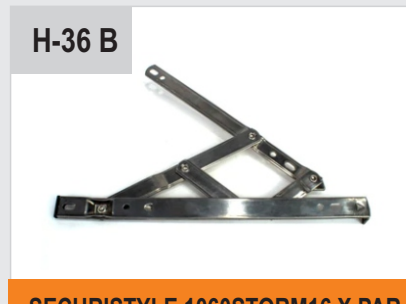

H-36 B

**SECURISTYLE 1060STORM16 X PAR
MONPAT 1074070130A14 X PAR**

Limitador de apertura para ventana desplazable.



H-36 C

**SECURISTYLE 1060STORM22 X PAR
MONPAT 1074070131A14X PAR**

Bisagra a Fricción 550



H-36 D

**SECURISTYLE 1060STORM26 X PAR
MONPAT 1074070135A14 X PAR**

Bisagra a Fricción 650



H-36 E

MONPAT 1074070132A14 X PAR

Bisagra a Fricción 750



H-42

AXAL 10202153000 XPAR

Pasador para ventana y puerta abatible.



H-42

GIESSE 102111010N X1

Pasador para ventana y puerta abatible.



H-43

TANIT 10534033 X1

Traba Varillas



H-45

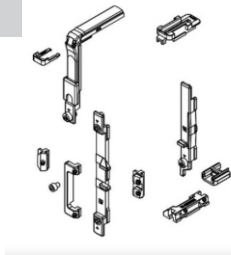

GIESSE 104704000 X1

Mecanismo Básico Oscilo-Batiente

H-45

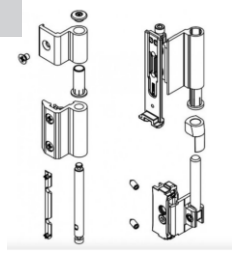

GIESSE 104711500/410 X1

Bisagra Oscilo-Batiente

H-45



GIESSE 101039500/410 X1

Falleba Prima Oscilo-Batiente

H-45



GIESSE 104284000 X1

Compas T1 Corto Oscilo-Batiente

H-45



GIESSE 104285000 X1

Compas T2 Largo Oscilo-Batiente

H-45



GIESSE 101076500/410 X1

Falleba Asia Oscilo-Batiente

H-47



GIESSE 101076500/410 X1

Falleba para ventana de abrir

H-47



GIESSE 101024500/410 X1

Falleba para ventana de abrir

H-49



AXAL 10102111010 X1

Pasador para ventana de abrir

H-50



GIESSE 102414500/410 X1

Manija Doble Balancín

H-50



MONPAT 1074040302BL4 X1

Manija Doble Balancín

H-50



GIESSE 102422500/410 X1

Manija Doble Balancín

H-50

MONPAT 1074040302BL4 X1

Manija Doble Balancín

H-50

GIESSE 102792500/410 X1

Manija Doble Balancín

H-51

**KALLAY 10902006802 X1
 MONPAT 1074160220NA4 X1
 MONPAT 107410112NE4 X1
 MONPAT 1074160312NA4 X1**

Cerradura caja de 80 mm

H-52

GIESSE 101704500/410 X1

Cierre bandolera

H-53

GIESSE 102040000K X PAR

Brazo sostén bandolera 250mm

H-53

GIESSE 102041000K X PAR

Brazo sostén bandolera 150mm

H-56

GIESSE 1029925000 X1

Cierre lateral con kit de enganche para ventana y puerta corrediza 90°

H-61

AXAL 10720300002612 X1

Bisagra de 2 piezas para cámara europea

H-61

GIESSE 100120500 X1

Bisagra de 2 piezas para cámara europea

H-62

AXAL 10720300002622 X1

Bisagra de 3 piezas para cámara europea

H-62

GIESSE 100600500N X1

Bisagra de 3 piezas para cámara europea

H-63

MONPAT 1074070317NE4 X1

Brazo de empuje ventiluz



H-63



GIESSE 100890500N X1

Brazo de empuje ventiluz

H-81



AXAL 10720300002812 X1

Bisagra de 2 piezas para tercer hoja

H-81



GIESSE 100890500N X1

Bisagra de 2 piezas para tercer hoja

H-82

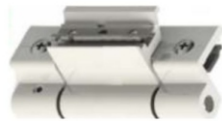

GIESSE 100601500 X1

Bisagra de 3 piezas para tercer hoja

H-89



GIESSE 103043500 X1

Tirador para hojas correderizas

H-91 MONACO



TANIT 1053506 X1

Aldaba para ventana desplazable Cp20

H-91



GIESSE 101642500N X1

Aldaba para ventana desplazable Cp20

H-92 ATENNAS



TANIT 1053520 X1

Aldaba para ventana desplazable Cp25

R-43



TANIT 10535069 INFERIOR X100
TANIT 10535060 SUPERIOR X100

Patín Mosquitero

R-48



MONPAT 1075013410NA1 X1

Rueda regulable simple con rulemán

R-49



MONPAT 1075013411NA1 X1

Rueda regulable doble con rulemán

S-09



AXAL 10300002009 X100

Grampa de amure

T-88 NYLON

API 1058T88 X100

Taco regulador para marco-premarco

T-88 ZAMAC

TANIT 10535059 X100

Taco regulador para marco - premarco

T-90

TANIT 10535003 X100

Tope guía parante central

T-91

TANIT 10535004 X50

Tapón guías laterales umbral y dintel corrediza

T-95

TANIT 10535013 X200

Tapa tornillo 11 mm

T-96

API 1058T96 X100

Clip contravidrios curvos

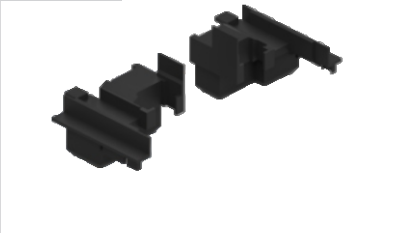
T-98

TANIT 10535064 X25

Tapón encuentro doble contacto central



T-131



TANIT 10535098 X100
API 1058T131 X100

Tapón desagote frontal caja de agua.

T-140



TANIT 10535123 X100

Tapón plano guías laterales umbral y dintel corrediza

T-143



TANIT 10535124 X50

Junta de estanqueidad marco corrediza 2 guías

T-144



TANIT 10535125 X20

Tapón cruce central de hojas para corrediza 90° 2 guías

T-146

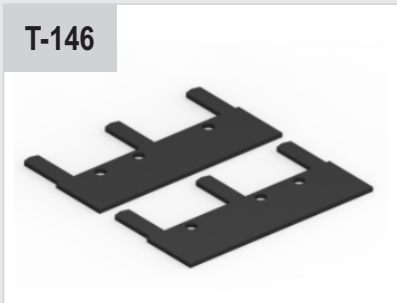

TANIT 10535127 X25

Junta de estanqueidad marco corrediza 3 guías

T-55



Clip tapa premarco

PLETINA



GIESSE 103524590N X6MTS

Pletina de accionamiento



A30

ACCESORIOS

B-9



PERFIGOM 10505224 X100

Burlete Tope Mosquitero

B-29



PERFIGOM 10501316 X100

Burlete Cuña 2 mm

B-30



PERFIGOM 10501317 X100

Burlete Cuña 3 mm

B-31



PERFIGOM 10501318 X100

Burlete Cuña 4 mm

B-52



PERFIGOM 10501336 X100

Burlete Interior Doble Contacto

B-57



PERFIGOM 10501341 X100

Burlete Tapa Premarco

B-60



PERFIGOM 10501344 X100

Burlete U para vidrio

B-67



PERFIGOM 10501350 X100

Burlete Hermeticidad Doble Contacto

B-68



PERFIGOM 10501351 X100

Burlete Exterior para vidrio



B-69



PERFIGOM 10501352 X100

Burlete Marco-Premarco

B-70



PERFIGOM 10501306 X100

Burlete Cierre Mosquitero

B-74



PERFIGOM 10501355 X100

Burlete Junta Abierta Ventana de abrir y desplazable

B-79



PERFIGOM 10501359 X100

Burlete Interior Doble Contacto

B-80



PERFIGOM 10501360 X100

Burlete Exterior opcional para triple contacto

C-3 FELPA



MONPAT 1074110201NE4 X1

Felpa de Polipropileno base 7 x 7 mm con Fin-Seal

E-66



API 1058E66 X100

Escuadra de Alineamiento Tapa Premarco

E-69



**MONTICELLI 1060E69 X1
COMUNELLO 19000002103 X1
AXAL 10720800002069 X1**

Escuadra de armado hoja mosquitero reforzado

E-70



**MONTICELLI 1060E70 X1
COMUNELLO 19000002105 X1
AXAL 1072800002070 X1**

Escuadra de armado hojas puerta de rebatir

E-73 ALUMINIO



TANIT 10535033 X50

Escuadra de armado mosquitero

E-73 NYLON



TANIT 10537505 X100

Escuadra de armado mosquitero

E-76



TANIT 10537505 X100

Escuadra de alineamiento de hojas batientes

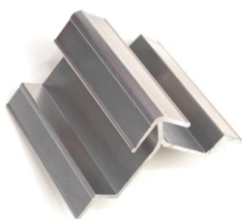
E-78 ALUMINIO

TANIT 10537505 X40

Escuadra de armado Premarco

E-78 NYLON

API 1058E78 X100

Escuadra de armado Premarco

E-79

TANIT 10537507 X40

Escuadra de armado Premarco para marco de 3 guías

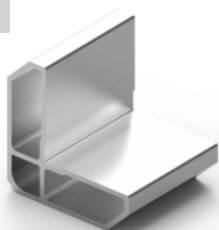
E-80

TANIT 10537508 X40

Escuadra suplementaria puerta de rebatir

E-83

**MONTICELLI 1060E83 X1
COMUNELLO 19000002110 X1
AXAL 10720800003083 X1**

Escuadra de armado

E-84

TANIT 10535022 X20

Soporte travesaño paño fijo

E-99

AXAL 1030002099 X100

Escuadra de armado guía mosquitero reforzado

H-36 A

SECURISTYLE 1060STORM10 X100

Bisagra a Fricción 250

H-36 B

**SECURISTYLE 1060STORM16 X100
MONPAT 1074070130AI4 XPAR**

Bisagra a Fricción 400

H-36 C

**SECURISTYLE 1060STORM22 X100
MONPAT 1074070131AI4 X100**

Bisagra a Fricción 550

H-36 D

**SECURISTYLE 1060STOR M26 XPAR
MONPAT 1074070135AI4 X100**

Bisagra a Fricción 730

H-36 E

MONPAT 1074070132AI4 X100

Limitador de apertura para ventana desplazable



H-42



AXAL 10202153000 XPAR

Pasador para ventana y
puerta de rebatir

H-42



GIESSE 102111010N X1

Pasador para ventana y
puerta de rebatir

H-43



TANIT 10534033 X1

Traba varilla para terminal o pasador

H-45

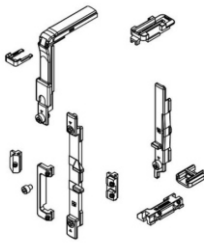

GIESSE 104704000 X1

Mecanismo Básico Oscilo-Batiente

H-45

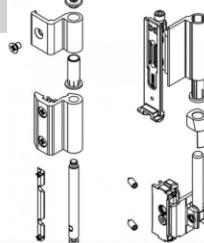

GIESSE 104711500/410 X1

Bisagra Oscilo-Batiente

H-45



GIESSE 101039500/410 X1

Falleba Prima Oscilo-Batiente

H-45



GIESSE 104284000 X1

Compas T1 Corto Oscilo-Batiente

H-45

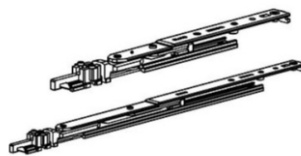

GIESSE 104285000 X1

Compas T2 Largo Oscilo-Batiente

H-45



GIESSE 101076500/410 X1

Falleba Asia Oscilo-Batiente

H-47



GIESSE 101076500/410 X1

Falleba ventana de abrir con
bloques de conexión

H-47



GIESSE 101024500/410 X1

Falleba ventana de abrir con
bloques de conexión

H-50



GIESSE 102414500/410 X1

Manija doble balancín para puerta
de rebatir

H-50

MONPAT 1074040302BL4 X1

Manija doble balancín para puerta de rebatir

H-50

GIESSE 102422500/410 X1

Manija doble balancín para puerta de rebatir

H-51

**KALLAY 10900512301 X1
MONPAT1074160220NA4 X1
MONPAT 107410112NE4 X1
MONPAT 1074160313NA4 X1**

Cerradura caja de 90 mm

H-61

AXAL 10720300002612 X1

Bisagra de 2 alas

H-61

GIESSE 100120500 X1

Bisagra de 2 alas

H-62

AXAL 10720300002622 X1

Bisagra de 3 alas

H-62

GIESSE 100600500N X1

Bisagra de 3 alas

H-89

GIESSE 103043 X1

Manijon tirador redondeado

H-91

GIESSE 101642500N X1

Aldaba para ventana desplazable

H-92

TANIT 1053520 X1

Aldaba para ventana desplazable

H-101

GIESSE 10087350002 X1

Cierre lateral con kit de enganche para correderas

H-103

GIESSE 105160500 X1

Bisagra de aplicar de 2 piezas para hojas coplanar



H-104



GIESSE 105161500 X1

Bisagra de aplicar de 3 piezas para hojas coplanar

R-43



TANIT 10535069 INFERIOR X100
TANIT 10535060 SUPERIOR X100

Patín Mosquitero

R-46



GIESSE 103146000 X1

Rueda regulable simple

R-47



GIESSE 103136000 X1

Rueda regulable doble

S-09



AXAL 10300002009 X100

Grampa de amure

T-88 NYLON



API 1058T88 X100

Taco regulador para fijación de marco

T-88 ZAMAC



TANIT 10535059 X100

Taco regulador para fijación de marco

T-95



TANIT 10535013 X200
API 1058T95 X100

Tapa Tornillo 11mm

T-96



API 1058T96 X100

Clip para contravidrios curvos

T-100



TANIT 10535056 X100

Tapa tornillo 13mm

T-112



TANIT 10537519 X50

Junta de estanqueidad marco
corrediza 2 guías

T-113



TANIT 10537520 X25

Junta de estanqueidad marco
corrediza 3 guías



API 1058T115 X100

Clip para tapa premarco

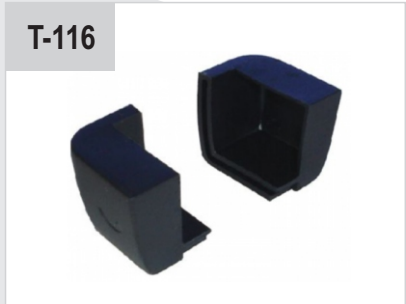

TANIT 10537522 X50

Tapón guías laterales umbral y dintel corrediza



TANIT 10537523 X50

Tope guía parante lateral



TANIT 10537547 X50

Tope guía parante central



TANIT 10537527 X100

Porta felpa parante puerta de rebatir



TANIT 10537528 X100

Tapón inferior y superior parante lateral corrediza



TANIT 10535097 X100
API 1058T130 X100

Boca desagüe caja de agua



TANIT 10535098 X100
API 1058T131 X100

Tapa desagote frontal caja de agua



TANIT 10537548 X8

Tapón cruce central de hojas para corrediza 2 guías



TANIT 10537529 X8

Tapón cruce central de hojas para corrediza 3 guías



GIESSE 103524590N X6MTS

Pletina de accionamiento



ACCESORIOS

B-9



PERFIGOM 10505224 X100

Burlete Tope Mosquitero

B-29



PERFIGOM 10501316 x100

Burlete Cuña 2 mm

B-30



PERFIGOM 10501317 x100

Burlete Cuña 3 mm

B-31



PERFIGOM 10501318 x100

Burlete Cuña 4 mm

B-57



PERFIGOM 10501341 x100

Burlete Tapa Premarco

B-68



PERFIGOM 10501351 x100

Burlete exterior para vidrio

B-69



PERFIGOM 10501352 x100

Burlete marco-premarco

B-70



PERFIGOM 10501306 x100

Burlete cierre mosquitero

B-80



PERFIGOM 10501360 x100

Burlete exterior doble contacto

B-81

PERFIGOM 10501361 x50

Burlete junta abierta

B-85

PERFIGOM 10501368 X00

Burlete hermeticidad contacto interno

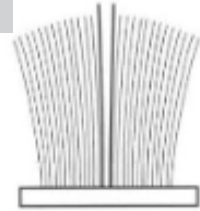
C-14

MONPAT 1074110201NE4 X300
AXAL 10721500007602 X300

Felpa 7 x 6 con Fin-Seal

E-62

AXAL 11100003062 X100

 Escuadra de alineamiento hoja
 corrediza

E-66

API 1058E66 X100

 Escuadra de alineamiento tapa
 premarco

E-68 ALUMINIO

AXAL 1072300002068 X1

Escuadra de armado premarco

E-68 NYLON

API 1058E68 X100

Escuadra de armado premarco

E-73 ALUMINIO

TANIT 10535033 X50

Escuadra de armado mosquitero

E-73 NYLON

TANIT 10537505 X100

Escuadra de armado mosquitero

E-84

TANIT 10535022 X20

Soporte travesaño paño fijo

E-101

MONTICELLI 1060E101 X1
AXAL 108000002101 X1

Escuadra de armado hojas batientes

E-102

MONTICELLI 1060E102 X1
AXAL 10720800000664 X1

 Escuadra de armado hoja puerta
 de rebatir



E-103

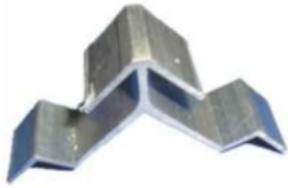

**TANIT 10537513 X40
AXAL 10300002103**

Escuadra suplementaria hoja puerta de rebatir

E-104



**MONTICELLI 1060E104 X1
AXAL 10720800000300 X1**

Escuadra de armado marco y hoja corrediza y marcos batientes

E-110



AXAL 10300002119 X40

Escuadra de alineación marco corrediza

H-36 A



**SECURISTYLE 1060STORM10 X PAR
MONPAT 1074070130A14 X PAR**

Bisagra a Fricción 250

H-36 B



**SECURISTYLE 1060STORM16 X PAR
MONPAT 1074070130A14 X PAR**

Bisagra a Fricción 400

H-36 C



**SECURISTYLE 1060STORM22 X PAR
MONPAT 1074070131A14 X PAR**

Bisagra a Fricción 550

H-36 D



**SECURISTYLE 1060STORM26 X PAR
MONPAT 1074070135A14 X PAR**

Bisagra a Fricción 730A

H-36 E



MONPAT 1074070132A14 X PAR

Limitador de apertura para ventana desplazable

H-45

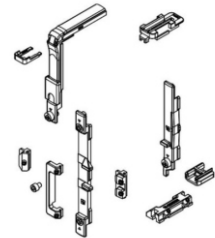

GIESSE 104704000 X1

Mecanismo Básico Oscilo-Batiente

H-45

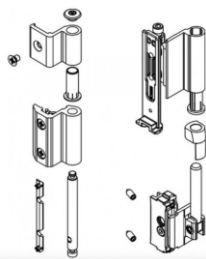

GIESSE 104711500/410 X1

Bisagra Oscilo-Batiente

H-45



GIESSE 101039500/410 X1

Falleba Prima Oscilo-Batiente

H-45

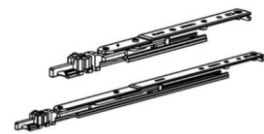

GIESSE 104284000 X1

Compas T1 Corto Oscilo-Batiente



GIESSE 104285000 X1

Compas T2 Largo Oscilo-Batiente



GIESSE 101076500/410 X1

Falleba Asia Oscilo-Batiente



GIESSE 102414500/410 X1

Falleba ventana de abrir con bloques de conexión



GIESSE 101024500/410 X1

Falleba ventana de abrir con bloques de conexión



GIESSE 102414500/410 X1

Manija doble balancín para puerta de rebatir



MONPAT 1074040302BL4 X1

Manija doble balancín para puerta de rebatir



GIESSE 102422500/410 X1

Manija doble balancín para puerta de rebatir



MONPAT 1074040302BL4 X1

Manija doble balancín para puerta de rebatir



GIESSE 102792500/410 X1

Manija doble balancín para puerta de rebatir



KALLAY 10902006802 X1
MONPAT 1074160220NA4 X1
MONPAT 107410112NE4 X1
MONPAT 1074160312NA4 X1

Cerradura puerta de rebatir



AXAL 10720300002612 X1

Bisagra de 2 alas



GIESSE 100120500 X1

Bisagra de 2 alas



H-62



AXAL 10720300002622 X1

Bisagra de 3 alas

H-62



GIESSE 100600500N X1

Bisagra de 3 alas

H-91 MONACO



TANIT 1053506 X1

Aldaba para ventana desplazable

H-91



GIESSE 101642500N X1

Aldaba para ventana desplazable

H-92 ATENNAS



TANIT 1053520 X1

Aldaba para ventana desplazable

R-43



TANIT 10535069 INFERIOR X100
TANIT 10535060 SUPERIOR X100

Patín Mosquitero

R-53



PABOSE 1060R53 X1

Rueda regulable simple 40 kg

R-54



PABOSE 1060R54 X1

Rueda regulable doble 80 kg

S-09



AXAL 10300002009 X100

Grampa de amure

T-87

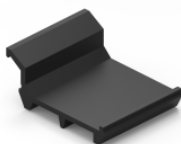

API 1058T87 X100
TANIT 10535000 X100

Clip soporte tapa premarco

T-88 NYLON



API 1058T88 X100

Taco regulador para fijación de marco

T-88 ZAMAC



TANIT 10535059 X100

Taco regulador para fijación de marco



T-95



TANIT 10535013 X200
API 1058T95 X100

Tapa tornillo 11 mm

T-96



API 1058T96 X100

Clip para contravidrios curvos

T-100



TANIT 10535056 X100

Tapa tornillo 13 mm

T-118



TANIT 10537547 X50

Tope guía parante central

T-130



TANIT 10535097 X100
API 1058T130 X100

Boca desagüe entre guías caja de agua

T-131



TANIT 10535098 X100
API 1058T131 X100

Tapa desagote frontal caja de agua

T-137



TANIT 10537541 X8

Tapón cruce central de hojas

T-168

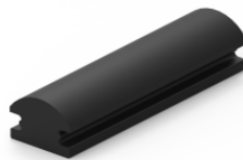

TANIT 10534563 X100

Guiador de hoja corrediza

T-169



TANIT 10534564 X50

Tope de hoja corrediza

T-171



TANIT 10534546 X20

Tapón hermeticidad caja de agua

PLETINA



GIESSE 103524590N X6MTS

Pletina de accionamiento

PERFIL "J"

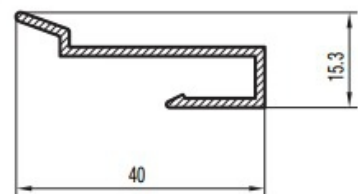

Aluar BA1019916 x1

Perfil "J" de PVC para aplicación en cruce central de hojas corredizas



Trialum

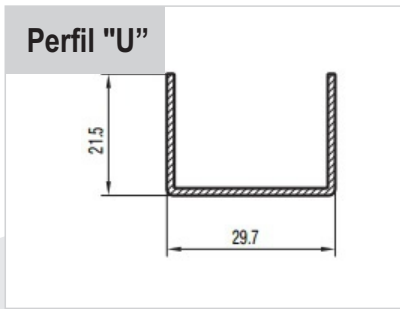

Aluar BA1019917 x1

Perfil "U" de PVC para colocar entre guías de marco corrediza

ACCESORIOS

B-9



PERFIGOM 10505224 X100

Burlete Tope Mosquitero

B-29



PERFIGOM 10501316 X100

Burlete Cuña 2 mm

B-30



PERFIGOM 10501317 X100

Burlete Cuña 3 mm

B-31



PERFIGOM 10501318 X100

Burlete Cuña 4 mm

B-57



PERFIGOM 10501341 X100

Burlete Tapa Premarco

B-60



PERFIGOM 10501344 X100

Burlete U para vidrio corrediza

B-67



PERFIGOM 10501350 X100

Burlete Hermeticidad Doble Contacto

B-68



PERFIGOM 10501351 X100

Burlete Exterior para vidrio

B-74



PERFIGOM 10501355 X100

Burlete Junta Abierta ventana de abrir y desplazable



B-79



PERFIGOM 10501359 X100

Burlete interior doble contacto

B-80



PERFIGOM 10501360 X100

Burlete exterior doble contacto

C-14

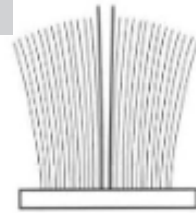

AXAL 10721500007602 X300
MONPAT 1074110201NE4 X300

Felpa 7 x 6 con Fin-Seal

E-66



API 1058E66

Escuadra de Alineamiento Tapa Premarco

E-69



MONTICELLI 1060E69 X1
COMUNELLO 19000002103 X1
AXAL 10720800002069 X1

Escuadra de armado hojas y marcos

E-70



MONTICELLI 1060E70 X1
COMUNELLO 19000002105 X1
AXAL 1072800002070 X1

Escuadra de armado hojas puerta de rebatir

E-76



TANIT 10537505 X100

Escuadra de alineamiento marco y hoja puerta vaivén

E-78 ALUMINIO

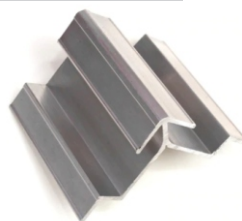

TANIT 10537505 X50

Escuadra de armado Premarco

E-78 NYLON



API 1058E78 X100

Escuadra de armado Premarco

E-79



TANIT 10537507 X40

Escuadra de armado Premarco

E-80

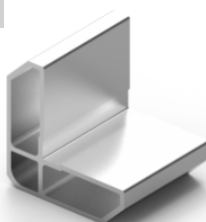

TANIT 10537508 X40
AXAL 10300003080 X1

Escuadra suplementaria puerta de rebatir

E-83



MONTICELLI 1060E83 X1
COMUNELLO 19000002110 X1
AXAL 10720800003083 X1

Escuadra de armado marco y hojas



TANIT 10535022 X20
Soporte travesaño paño fijo



AXAL 1030002099 X100
Escuadra de armado guía mosquitero



TANIT 10534263 X100
AXAL 10300002109
Escuadra de armado Premarco



SECURISTYLE 1060STORM10 X PAR
Bisagra a Fricción 250

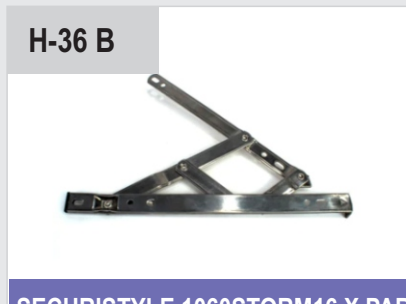

SECURISTYLE 1060STORM16 X PAR
MONPAT 1074070130AI4 X PAR
Bisagra a Fricción 400



SECURISTYLE 1060STORM22 X PAR
MONPAT 1074070131AI4 X PAR
Bisagra a Fricción 550



SECURISTYLE 1060STORM26 X PAR
MONPAT 1074070135AI4 X PAR
Bisagra a Fricción 730A



MONPAT 1074070132AI4 X PAR
Limitador de apertura para ventana desplazable



AXAL 10202153000 X PAR
Pasador puerta de rebatir de 2 hojas



GIESSE 102111010N X1
Pasador puerta de rebatir de 2 hojas



TANIT 10534033 X1
Traba varillas para terminal o pasador

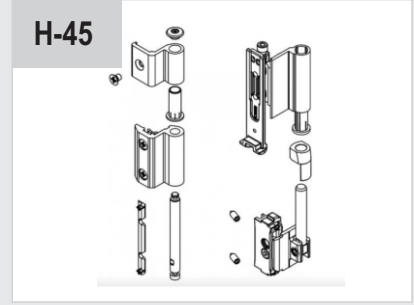

GIESSE 104711500/410 X1
Bisagra Oscilo-Batiente



H-45



GIESSE 101076500/410 X1

Falleba Asia Oscilo-Batiente

H-45



GIESSE 101039500/410 X1

Falleba Prima Oscilo-Batiente

H-45

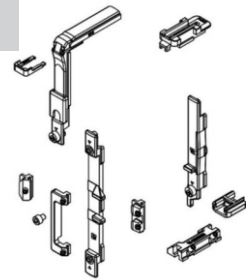

GIESSE 104704000 X1

Mecanismo Básico Oscilo-Batiente

H-45



GIESSE 104284000 X1

Compas T1 Corto Oscilo-Batiente

H-45

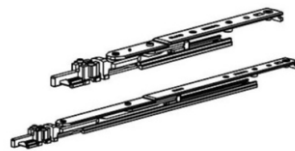

GIESSE 104285000 X1

Compas T2 Largo Oscilo-Batiente

H-47



GIESSE 101024500/410 X1

Falleba ventana de abrir con bloques de conexión

H-47



GIESSE 102414500/410 X1

Falleba ventana de abrir con bloques de conexión

H-50



GIESSE 102414500/410 X1

Manija doble balancín para puerta de rebatir

H-50



MONPAT 1074040302BL4 X1

Manija doble balancín para puerta de rebatir

H-50



GIESSE 102422500/410 X1

Manija doble balancín para puerta de rebatir

H-50



MONPAT 1074040302BL4 X1

Manija doble balancín para puerta de rebatir

H-50



GIESSE 102792500/410 X1

Manija doble balancín para puerta de rebatir

H-51



KALLAY 10902006802 X1
MONPAT1074160220NA4 X1
MONPAT 107410112NE4 X1
MONPAT 1074160313NA4 X1

Cerradura puerta de rebatir

H-61



AXAL 10720300002612 X1

Bisagra de 2 alas para hoja escalonada

H-61



GIESSE 100120500 X1

Bisagra de 2 alas para hoja escalonada

H-62



AXAL 10720300002622 X1

Bisagra de 3 alas para hoja escalonada

H-62



GIESSE 100600500N X1

Bisagra de 3 alas para hoja escalonada

H-81



AXAL 10720300002812 X1

Bisagra de 2 alas para hoja coplanar y tercer hoja

H-81



GIESSE 100890500N X1

Bisagra de 2 alas para hoja coplanar y tercer hoja

H-82



GIESSE 100601500 X1

Bisagra de 3 alas para hoja coplanar y tercer hoja

H-91



GIESSE 101642500N X1

Aldaba para ventana desplazable

H-91 MONACO



TANIT 1053506 X1

Aldaba para ventana desplazable

H-92 ATENNAS



TANIT 1053520 X1

Aldaba para ventana desplazable

H-103



GIESSE 105160500 X1

Bisagra de aplicar de 2 alas para hoja coplanar



H-104



GIESSE 105161500 X1

Bisagra de aplicar de 3 alas para hoja coplanar

R-46



GIESSE 103146000 X1

Rueda regulable simple 90 kg

R-47



GIESSE 103136000 X1

Rueda regulable doble 180 kg

S-09

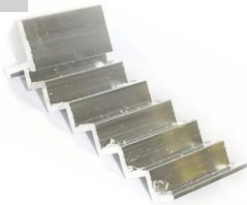

AXAL 10300002009 X100

Grampa de amure premarco

T-88 NYLON



API 1058T88 X100

Taco regulador para fijación de marco

T-88 ZAMAC



TANIT 10535059 X100

Taco regulador para fijación de marco

T-95



TANIT 10535013 X200
API 1058T95 X100

Tapa tornillo 11 mm para T1

T-96



API 1058T96 X100

Clip para contravidrios curvos

T-100



TANIT 10535056 X100

Tapa tornillo 13 mm para T2

T-130



TANIT 10535097 X100
API 1058T130 X100

Boca desagüe entre guías caja de agua

T-131



TANIT 10535098 X100
API 1058T131 X100

Tapa desagote frontal caja de agua

T-156



TANIT 10535520 X50

Tope guía parante central hojas 90° y 45°



TANIT 10534267 X50

Tope guía parante lateral hojas a 90°

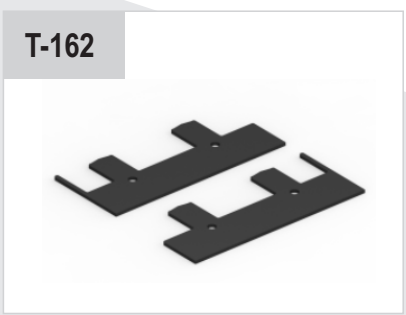

TANIT 1053425 X25

Junta de estanqueidad marco
corrediza 2 guías

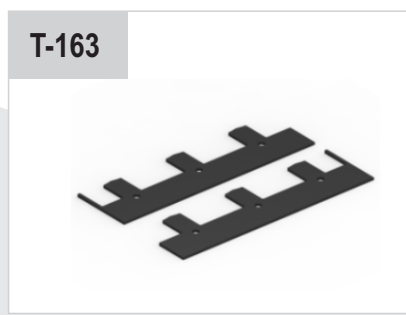

TANIT 10534262 X25

Junta de estanqueidad marco
corrediza 3 guías

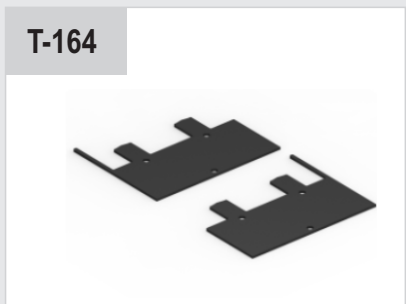

TANIT 10534254 X25

Junta de estanqueidad umbral
reforzado



TANIT 10534272 X20

Tope guía parante lateral hojas a 45°

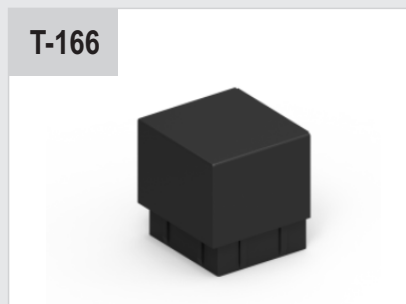

TANIT 10534571 X10

Tapón refuerzo parante central
hoja a 45°



TANIT 10534599 X100

Clip tapa premarco marcos 60 mm



TANIT 10534563 X100

Guiador de hojas corredizas corte a 45°

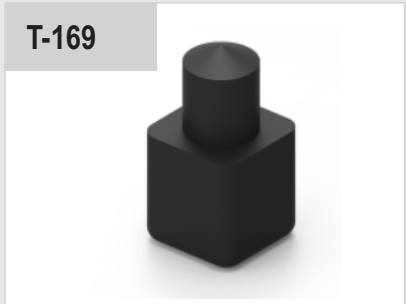

TANIT 10534564 X50

Tope de hojas corte a 45°



GIESSE 103524590N X6MTS

Pletina de accionamiento



A40RPT

ACCESORIOS

B-9



PERFIGOM 10505224 X100

Burlete Tope Mosquitero

B-29



PERFIGOM 10501316 X100

Burlete Cuña 2 mm

B-30



PERFIGOM 10501317 X100

Burlete Cuña 3 mm

B-31



PERFIGOM 10501318 X100

Burlete Cuña 4 mm

B-57



PERFIGOM 10501341 X100

Burlete Tapa Premarco

B-68



PERFIGOM 10501351 X100

Burlete Exterior para vidrio

B-80



PERFIGOM 10501360 X100

Burlete exterior doble contacto

B-81



PERFIGOM 10501361 X50

Burlete junta abierta

B-85



PERFIGOM 10501368 X100

Burlete hermeticidad contacto interno

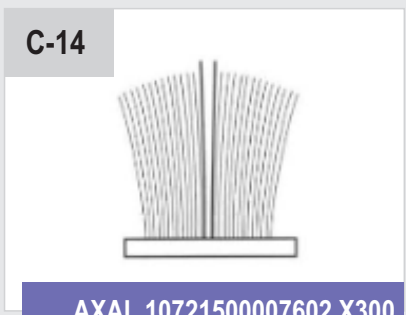

AXAL 10721500007602 X300
MONPAT 1074110201NE4 X300

Felpa 7 x 6 con Fin-Seal



AXAL 11100003062 X100

Escuadra de alineamiento
 hoja corrediza



API 1058E66 X100

Escuadra de alineamiento
 tapa premarco



MONTICELLI 1060E69 X1
COMUNELLO 19000002103 X1
AXAL 10720800002069 X1

Escuadra de armado hoja mosquitero
 y marcos 114 mm



TANIT 10537505 X50

Escuadra de armado premarco 8064



API 1058E78 X100

Escuadra de armado premarco 8064



TANIT 10537507 X40

Escuadra de armado premarco 6079



MONTICELLI 1060E83 X1
COMUNELLO 19000002110 X1
AXAL 10720800003083 X1

Escuadra de armado marco corrediza

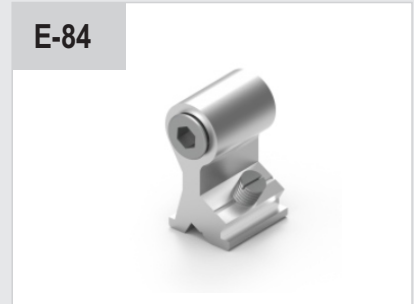

TANIT 10535022 X20

Soporte travesaño paño fijo



MONTICELLI 1060E97 X1
COMUNELLO 19000002107 X1
AXAL 10800002097 X1

Escuadra de armado hoja corrediza



AXAL 1030002099 X40

Escuadra de armado guía mosquitero
 y de alineación marcos y hojas
 batientes



MONTICELLI 1060E101 X1
AXAL 10800002101 X1

Escuadra de armado marcos
 y hojas batientes



E-102



MONTICELLI 1060E102 X1
AXAL 10720800000664 X1

Escuadra de armado hoja puerta de rebatir

E-103



TANIT 10537513 X1
AXAL 10300002103 X1

Escuadra suplementaria hoja puerta de rebatir

E-109



TANIT 10534263
AXAL 10300002109 X1

Escuadra de armado premarco 8265

H-36 A



SECURISTYLE 1060STORM10 X PAR

Bisagra a Fricción 250

H-36 B



SECURISTYLE 1060STORM16 X PAR
MONPAT 1074070130AI4 X PAR

Bisagra a Fricción 400

H-36 C



SECURISTYLE 1060STORM22 X PAR
MONPAT 1074070131AI4 X PAR

Bisagra a Fricción 550

H-36 D



SECURISTYLE 1060STORM26 X PAR
MONPAT 1074070135AI4 X PAR

Bisagra a Fricción 730A

H-36 E



MONPAT 1074070132AI4 X PAR

Limitador de apertura para ventana desplazable

H-42



AXAL 10202153000 X PAR

Pasador puerta de rebatir de 2 hojas

H-42



GIESSE 102111010N X1

Pasador puerta de rebatir de 2 hojas

H-43



TANIT 10534033 X1

Traba varillas para terminal o pasador

H-45

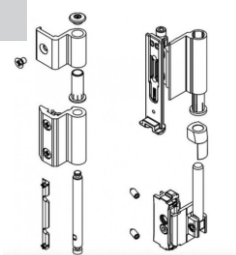

GIESSE 104711500/410 X1

Bisagra Oscilo-Batiente



GIESSE 101076500/410 X1

Falleba Asia Oscilo-Batiente

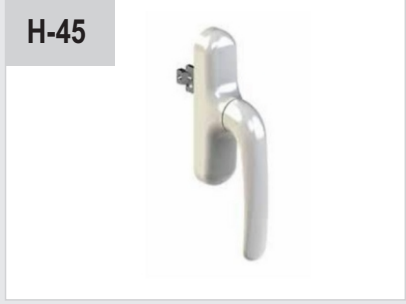

GIESSE 101039500/410 X1

Falleba Prima Oscilo-Batiente



GIESSE 104704000 X1

Mecanismo Básico Oscilo-Batiente



GIESSE 104284000 X1

Compas T1 Corto Oscilo-Batiente



GIESSE 104285000 X1

Compas T2 Largo Oscilo-Batiente



GIESSE 101024500/410 X1

Falleba ventana de abrir con bloques de conexión



GIESSE 102414500/410 X1

Falleba ventana de abrir con bloques de conexión



GIESSE 102414500/410 X1

Manija doble balancín para puerta de rebatir



MONPAT 1074040302BL4 X1

Manija doble balancín para puerta de rebatir



GIESSE 102422500/410 X1

Manija doble balancín para puerta de rebatir



MONPAT 1074040302BL4 X1

Manija doble balancín para puerta de rebatir



GIESSE 102422500/410 X1

Manija doble balancín para puerta de rebatir



H-51



KALLAY 10902006802 X1
MONPAT1074160220NA4 X1
MONPAT 107410112NE4 X1
MONPAT 1074160313NA4 X1

Cerradura puerta de rebatir

H-61



AXAL 10720300002612 X1

Bisagra de 2 alas para hoja escalonada

H-61



GIESSE 100120500 X1

Bisagra de 2 alas para hoja escalonada

H-62



AXAL 10720300002622 X1

Bisagra de 3 alas para hoja escalonada

H-62



GIESSE 100600500N X1

Bisagra de 3 alas para hoja escalonada

H-91 MONACO



TANIT 1053506 X1

Aldaba para ventana desplazable

H-91



GIESSE 101642500N X1

Aldaba para ventana desplazable

H-92 ATENNAS



TANIT 1053520 X1

Aldaba para ventana desplazable

R-46



GIESSE 103146000 X1

Rueda regulable simple 90 kg

R-47



GIESSE 103136000 X1

Rueda regulable doble 180 kg

S-09



AXAL 10300002009 X100

Grampa de amure

T-88 NYLON



API 1058T88 X100

Taco regulador para fijación de marco



TANIT 10535059 X100

Taco regulador para fijación de marco



**TANIT 10535013 X200
API 1058T95 X100**

Tapa tornillo 11 mm



API 1058T96 X100

Clip para contravidrios curvos



TANIT 10535056 X100

Tapa tornillo 13 mm



**TANIT 10535097 X100
API 1058T130 X100**

Boca desagüe entre guías caja de agua



**TANIT 10535098 X100
API 1058T131 X100**

Tapa desagote frontal caja de agua

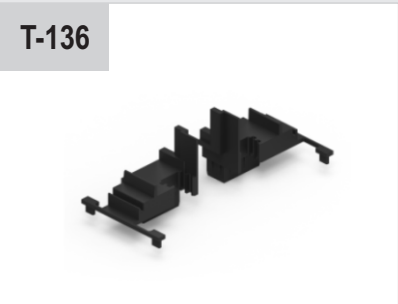

TANIT 10533978 X10

Tapón encuentro central ventana de abrir / puerta de rebatir



TANIT 10535520 X50

Tope guía parante central

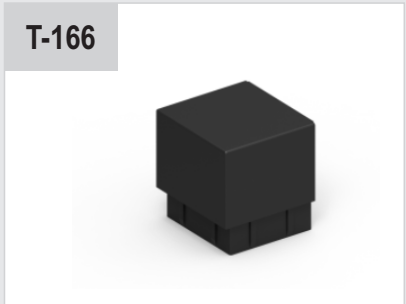

TANIT 10534571 X10

Tapón parante reforzado



TANIT 10534599 X100

Clip tapa premarco marcos 60 mm



TANIT 10534563 X100

Guiador de hoja corrediza

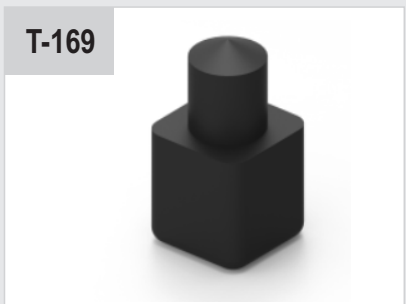

TANIT 10534564 X50

Tope de hoja corrediza



T-170

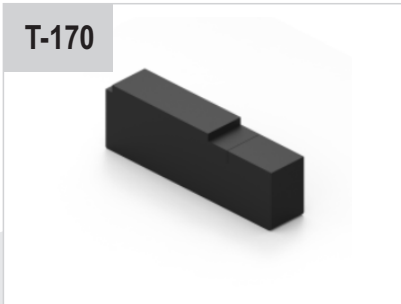

TANIT 10534589 X20

Tapón hermeticidad caja de agua

T-173



TANIT 16052 X4

Tapón hermeticidad caja de agua marco de 3 guías

PLETINA



GIESSE 103524590N X6MTS

Pletina de accionamiento

PERFIL "U"

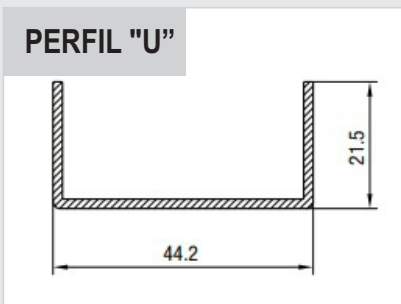

ALUAR BA1034031 X1

Perfil "U" de PVC para colocar entre guías de marco corrediza

PERFIL "LABERINTO"

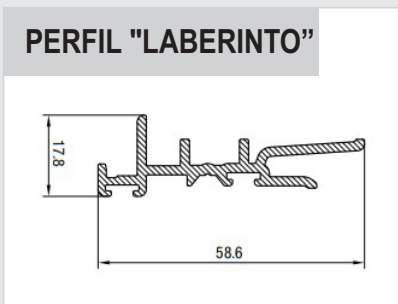

ALUAR BA1021117 X1

Perfil de poliamida complemento de cruce central de hojas corredizas

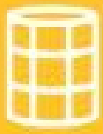

PIEL DE VIDRIO

ACCESORIOS

AHI

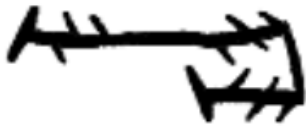

PERFIGOM 10501027 X100

Burlete U para vidrio de 4 a 6 mm

AHJ

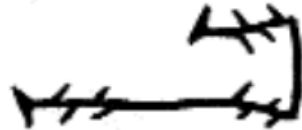

PERFIGOM 10501028 X50

Burlete U para vidrio de 8 a 10 mm

AHL



MONPAT 1075020233NA1 X1
AXAL 10300000178 X14

Anclaje media columna

AHK



AXAL 10300000179 X12

Anclaje columna

B-29



PERFIGOM 10501316 X100

Burlete cuña 2 mm

B-30



PERFIGOM 10501317 X100

Burlete cuña 3 mm

B-31



PERFIGOM 10501318 X100

Burlete cuña 4 mm

B-68



PERFIGOM 10501351 X100

Burlete interior para hoja con
contravidrio

B-78

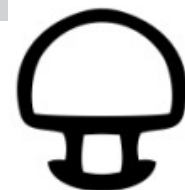

PERFIGOM 10501457 X100

Burlete hermeticidad doble contacto



B-79



PERFIGOM 10501359 X100

Burlete para travesaño

BPV



PERFIGOM 10501031 X100

Burlete hermeticidad doble contacto para hoja ventana desplazable

CONJUNTO 87°

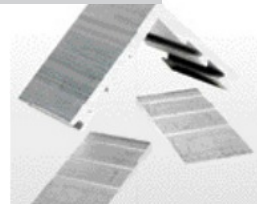

**AXAL 10300002401 X100
6152 / 6712 / 7900**

Escuadra cuña para perfiles

CONJUNTO 90°



AXAL 10300001090 X100

Escuadra de armado con tornillos para perfiles

E-88

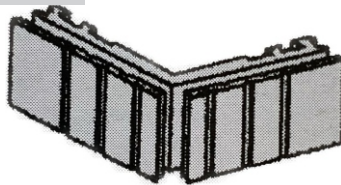

TANIT 1053587 X100

Escuadra cuña para perfiles

E-91

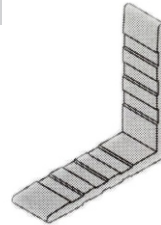

TANIT 1053590 X50

Escuadra suplementaria para perfil

H-36 A



SECURISTYLE 1060STORM10 X PAR

Bisagra a Fricción 250

H-36 B



**SECURISTYLE 1060STORM16 X PAR
MONPAT 1074070130AI4 X PAR**

Bisagra a Fricción 400

H-36 C



**SECURISTYLE 1060STORM22 X PAR
MONPAT 1074070131AI4 X PAR**

Bisagra a Fricción 550

H-36 D



**SECURISTYLE 1060STORM26 X PAR
MONPAT 1074070135AI4 X PAR**

Bisagra a Fricción 730A

H-36 E



MONPAT 1074070132AI4 X PAR

Limitador de apertura para ventana desplazable

H-98

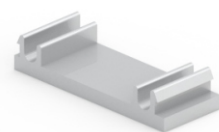

Soporte cierre de losas corto



AXAL 10300000312 X100
Soporte cierre de losas largo



AXAL 10300000312 X100
Presilla fijación paño fijo lado columna



AXAL 10300000312 X100
Presilla fijación paño fijo lado hoja



GIESSE 101642500N X1
Cierre aldaba hoja desplazable



AXAL 10300000121 X100
Soporte fijación travesaño

SORT



A40 CRISTAL

ACCESORIOS

B-86



PERFIGOM 10501369 X100

Burlete exterior

B-87



PERFIGOM 10501370 X100

Burlete interior para vidrio 10+10

B-88



PERFIGOM 10501371 X100

Burlete interior para vidrio 8+8

T-179

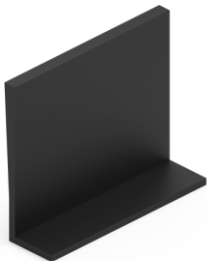

MONPAT 1075060230NN1 X1

"L" apoyo vidrio lado exterior

T-180



MONPAT 1075060210NN1 X1

Cuña para vidrio 10+10

T-181

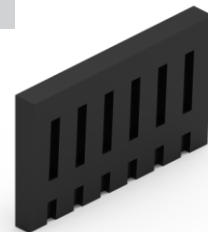

MONPAT 10750232NN1 X1

Cuña para vidrio 8+8

T-182



CURAPALIGUE 10136T182 X1

Tapa Lateral para perfil 8621

T-183



CURAPALIGUE 10136T183 X1

Tapa Lateral para perfil 8623

T-184



CURAPALIGUE 10136T184 X1

Tapa Lateral para perfil 8625



CURAPALIGUE 10136T185 X1

Tapa Lateral para perfil 8626



CURAPALIGUE 10136T186 X1

Tapa Lateral para perfil 8631

SORT



 **GIESSE**
TYMAN group

fapim[®]
Life in evolution

 **TANIT**
ACCESORIOS Y RODAMIENTOS PARA ABERTURAS

 **MONPAT**
INNOVACIÓN EN HERRAJES

 **Trialum**

Av. Monseñor Zabala 172 | Mar del Plata
Ruta 2 km 37.5 | Parque Industrial Pibera | Buenos Aires
info@trialum.com.ar | 0223 470-2184 | @trialum.ar